

## CYB-K4G100 Elektrikli Strik Kilidi

The electric strike lock is designed for wooden door, metal door, and PVC door. It can work depending on the thrust or pull producing by the electromagnetism.



### Available Model

CYB-K4G100

### Key Feature

- Fail-secure and fail-safe selectable
- Material of latch: US304 stainless steel  
Material of plate: wire-drawing on the surface
- The magnetic lock supports static linear thrust of 800 kg (1764 lb)
- 100,000 times usage of the electromagnetic coil when powering on
- Depth of the latch groove: 15 mm
- Strong suction which protects the door from forced opening when the door is locked
- Double insulation

## Specifications

<b>Model</b>	<b>CYB-K4G100</b>
Dimension of lock body (L × W × H)	165 mm × 43.7 mm × 35 mm (6.5" × 1.7" × 1.4")
Material of latch	Stainless steel
Maximum thrust	800 kg (1764 lb)
Input voltage	12 VDC, 320 mA/24 VDC, 160 mA ± 15%
Signal Output	Dry contact signal output; NO output while locking and NC output while unlocking
Suitable door	Wooden door, metal door, PVC door
Working temperature	-10 °C to 55 °C (14 °F to 131 °F)
Working humidity	0 to 95% (non-condensing)
Weight	0.4 kg (0.9 lb)

## Dimension

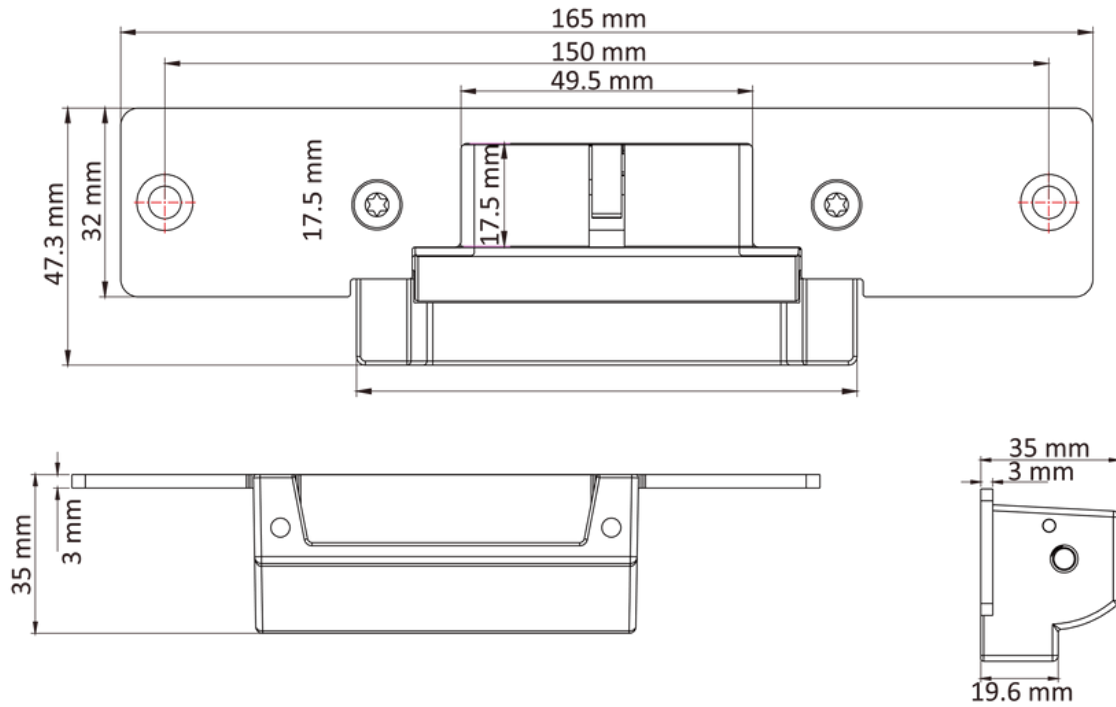

## Circuit Board Diagram

COLOR	5-PIN
Red	+
Black	-
White	COM
Yellow	NC
Green	NO

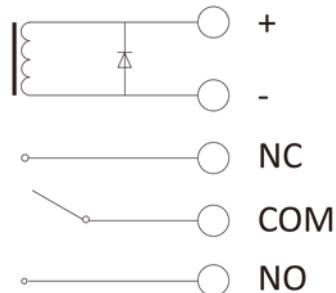

## Installation

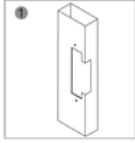

1 Drill a hole according to the strike dimension.



2 Insert the faceplate.

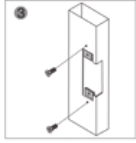

3 Secure the faceplate with two screws.

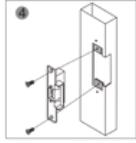

4 Install the strike body in the drilled hole and wire the power cable and start test.

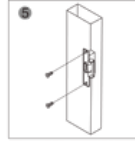

5 Secure the strike body with two screws.

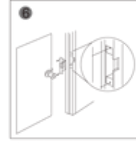

6 Finish installation.

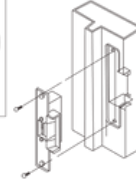

Metal Door Frame

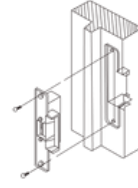

Wooden Door Frame

Distributed by

