

DS-2CE72DF8T-FSLN 2 MP ColorVu Audio Fixed Turret Camera



- High quality imaging with 2 MP, 1920 × 1080 resolution
- 24/7 color imaging with F1.0 aperture
- Clear imaging against strong back light due to 130 dB true WDR technology
- 3D DNR technology delivers clean and sharp images
- 2.8 mm, 3.6 mm fixed focal lens
- Up to 40 m white light distance for bright night imaging
- High quality audio with audio over coaxial cable, built-in mic
- One port for four switchable signals (TVI/AHD/CVI/CVBS)
- Water and dust resistant (IP68)

▪ Specification

Camera	
Image Sensor	2 MP CMOS
Max. Resolution	1920 (H) × 1080 (V)
Min. Illumination	0.0003 Lux @ (F1.0, AGC ON), 0 Lux with white light
Shutter Time	PAL: 1/25 s to 1/50,000 s; NTSC: 1/30 s to 1/50,000 s
Day & Night	24/7 Color Imaging
Angle Adjustment	Pan: 0° to 360°, Tilt: 0° to 75°, Rotation: 0° to 360°
Signal System	PAL/NTSC
Slow Shutter	Max. 16 times
Lens	
Lens Type	Fixed focal lens, 2.8 mm and 3.6 mm optional
Focal Length & FOV	2.8 mm, horizontal FOV: 106°, vertical FOV: 56°, diagonal FOV: 129° 3.6 mm, horizontal FOV: 83°, vertical FOV: 44°, diagonal FOV: 100°
Lens Mount	M12
Illuminator	
Supplement Light Type	White Light
Supplement Light Range	Up to 40 m
Smart Supplement Light	Yes
Supplement Light Type	White Light
Image	
Image Parameters Switch	STD/HIGH-SAT/HIGHLIGHT
Image Settings	Brightness, Contrast, Mirror, Sharpness, Smart Light, Anti-Banding, AGC
Frame Rate	TVI: 1080p @ 25 fps/30 fps CVI: 1080p @ 25 fps/30 fps AHD: 1080p @ 25 fps/30 fps CVBS: PAL/NTSC
Day/Night Mode	Color
Wide Dynamic Range (WDR)	≥130 dB
Image Enhancement	BLC, HLC, Global, HLS
Privacy Mask	4 programmable privacy masks
Noise Reduction	3D DNR/2D DNR
White Balance	Auto
Interface	
Video Output	Switchable TVI/AHD/CVI/CVBS
Alarm	Solid Light Alarm (White Light)
Audio	Line-in
Built-in Microphone	Yes
Event	
Motion Detection	4 programmable motion areas
General	
Power	12 VDC ± 25%, max. 6.3 W *You are recommended to use one power adapter to supply the power for one camera.
Material	Main body: Metal, Enclosure: Plastic

Dimension	Φ 109.98 mm × 98.27 mm (Φ 4.33" × 3.87")
Weight	Approx. 350 g (0.77 lb.)
Operating Condition	-40°C to 60°C (-40°F to 140°F), humidity: 90% or less (non-condensing)
Communication	HIKVISION-C
Language	English
Approval	
Protection	IP68

▪ **Available Model**

DS-2CE72DF8T-FSLN(2.8mm)

DS-2CE72DF8T-FSLN(3.6mm)





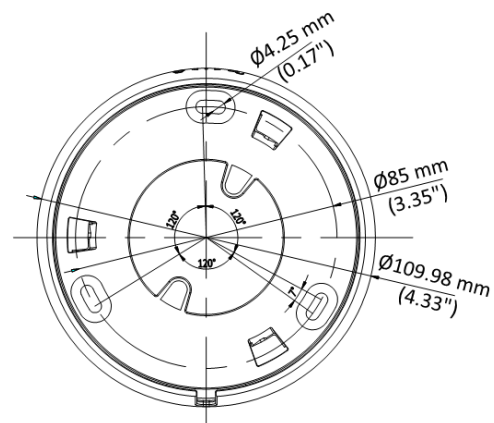
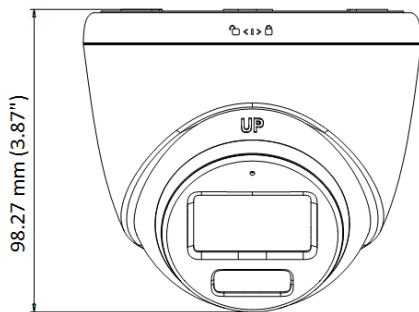

DS-2CE72DF8T-FSLN(6mm)

▪ **Dimension**



▪ **Accessory**

▪ **Optional**

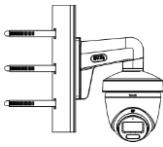
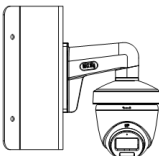
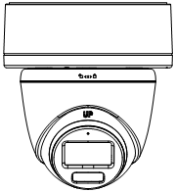
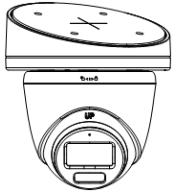
DS-1272ZJ-110-TRS Wall mount	DS-1275ZJ-SUS Vertical pole mount	DS-1276ZJ-SUS Corner mount	DS-1280ZJ-S Junction box	DS-1281ZJ-S Inclined ceiling mount
				
				

Headquarters

No.555 Qianmo Road, Binjiang District,
Hangzhou 310051, China
T +86-571-8807-5998
www.hikvision.com



Follow us on social media to get the latest product and solution information.

